

R8FK024 Datasheet

Technical Specifications

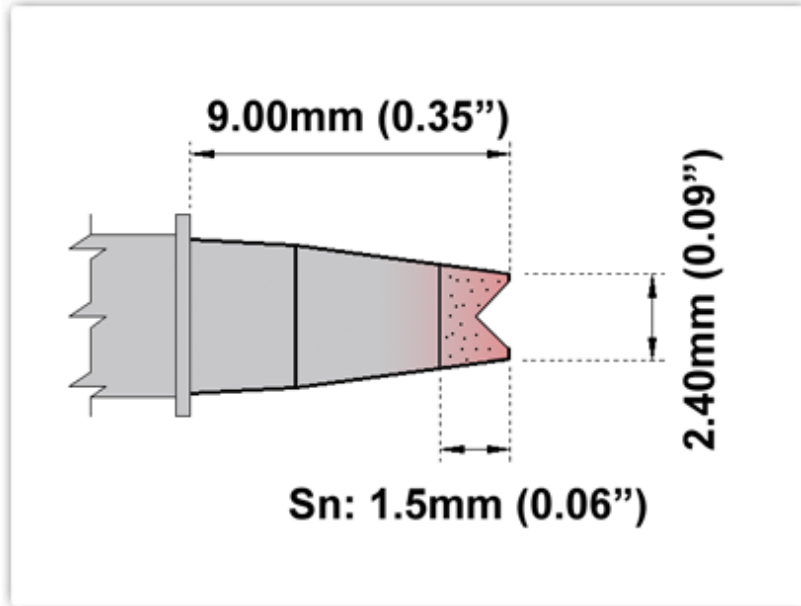

R8FK024

Fork Chisel 2.4mm (0.09")

Tip Style: Fork Chisel

Tip Width: 2.40mm (0.09")

Tip Length: 9.00mm (0.35")

800 Type Cartridge ¹ :	420°C - 475°C
RoHS Compliant ² / Lead Free:	YES
For Use With:	TMT-R8000S, TMT-R9000S, TMT-R9800S, TMT-R9900S

Material Composition



**All components
are RoHS
compliant and
Lead-Free.**

¹ Thermaltronics tip cartridges will typically idle within a temperature range of +/-1.1°C. However, there is variation in idle temperature across tip geometries within an individual temperature series. Thermaltronics offers a wide variety of tip geometries from 0.25mm fine point tip to 5mm chisel. The length and geometry of a tip will have an influence on the tip idle temperature. To accurately measure idle temperature it will depend greatly on the measurement method, technique and equipment used. Two different methods or the use of alternative equipment will produce different test results.

² Please refer to [European Commission](#) for details on RoHS Compliance.